

# JVC<sup>®</sup>

## COLOR TELEVISION USER'S GUIDE

*For models:  
AV-24F704  
AV-20F704  
AV-14F704*

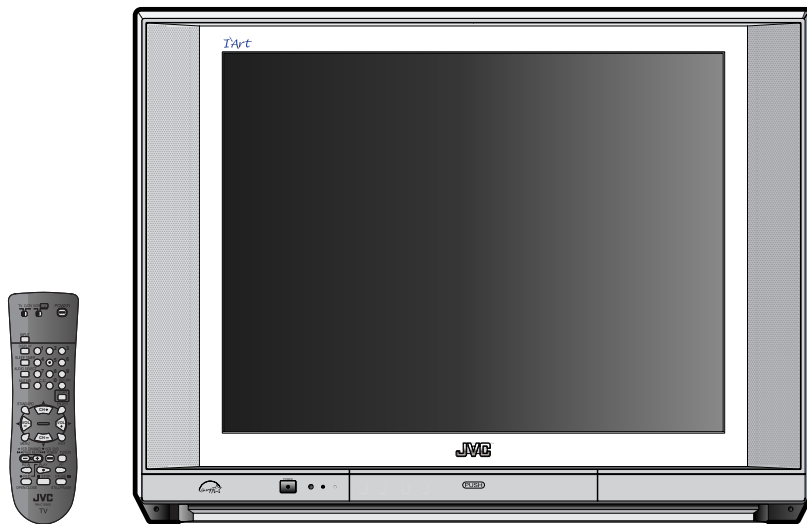

**Illustration of AV-24F704 and RM-C1256G**

**IMPORTANT NOTE TO THE CUSTOMER:**

In the space below, enter the serial number for your television (located on the rear of the television cabinet).  
Staple your sales receipt or invoice to the inside cover of this guide.  
Keep this user's guide in a convenient place for future reference.  
Keep the carton and original packaging for future use.



\*J3M80301A\*

---

Serial Number



The lightning flash with arrowhead symbol, within an equilateral triangle is intended to alert the user to the presence of uninsulated dangerous voltage within the product's enclosure that may be of sufficient magnitude to constitute a risk of electric shock.



The exclamation point within an equilateral triangle is intended to alert the user to the presence of important operating and maintenance (servicing) instructions in the literature accompanying the appliance.

**CAUTION:** Changes or modifications not expressly approved by the party responsible for compliance with the FCC Rules could void the user's authority to operate this equipment.

**WARNING:** TO PREVENT FIRE OR SHOCK HAZARD, DO NOT EXPOSE THIS APPLIANCE TO RAIN OR MOISTURE.  
**CAUTION:** TO PREVENT ELECTRIC SHOCK DO NOT USE THIS POLARIZED PLUG WITH AN EXTENSION CORD, RECEPTACLE OR OTHER OUTLET UNLESS THE BLADES CAN BE FULLY INSERTED TO PREVENT BLADE EXPOSURE.

## IMPORTANT SAFEGUARDS

### 1. READ INSTRUCTIONS

All the safety and operating instructions should be read before the unit is operated.

### 2. RETAIN INSTRUCTIONS

The safety and operating instructions should be retained for future reference.

### 3. HEED WARNINGS

All warnings on the unit and in the operating instructions should be adhered to.

### 4. FOLLOW INSTRUCTIONS

All operating and use instructions should be followed.

### 5. CLEANING

Unplug this unit from the wall outlet before cleaning. Do not use liquid cleaners or aerosol cleaners. Use a damp cloth for cleaning the exterior cabinet only.

### 6. ATTACHMENTS

The manufacturer of this unit does not make any recommendations for attachments, as they may cause hazards.

### 7. WATER AND MOISTURE

Do not use this unit near water. For example, near a bathtub, washbowl, kitchen sink, laundry tub, in a wet basement, or near a swimming pool.

### 8. ACCESSORIES

Do not place this unit on an unstable cart, stand, tripod, bracket, or table.

The unit may fall, causing serious injury, and serious damage to the unit.

- 8A.** An appliance and cart combination should be moved with care. Quick stops, excessive force, and uneven surfaces may cause the appliance and cart combination to overturn.

### 9. VENTILATION

Slots and openings in the cabinet back or bottom are provided for ventilation, and to ensure reliable operation of the unit, and to protect it from overheating. These openings must not be blocked or covered. The openings should never be blocked by placing the unit on a bed, sofa, rug, or other similar surface. This unit should never be placed near or over a radiator or heat source.

This unit should not be placed in a built-in installations such as a bookcase or rack unless proper ventilation is provided or the manufacturer's instructions have been adhered to.

### 10. POWER SOURCE

This unit should be operated only from the type of power source indicated on the rating plate. If you are not sure of the type of power supply to your home, consult your appliance dealer or local power company. For units intended to operate from battery power, or other sources, refer to the operating instructions.

### 11. GROUNDING OR POLARIZATION

This unit is equipped with a polarized alternating-current line plug (a plug having one blade wider than the other). This plug will fit into the power outlet only one way. This is a safety feature. If you are unable to insert the plug fully into the outlet, try reversing the plug. If the plug should still fail to fit, contact your electrician to replace your obsolete outlet. Do not defeat the safety purpose of the polarized plug, if your unit is equipped with a 3-wire grounding-type plug, a plug having a third (grounding) pin. This plug will only fit into a grounding-type power outlet. This too, is a safety feature. If you are unable to insert the plug into the outlet, contact your electrician to replace your obsolete outlet. Do not defeat the safety purpose of the grounding-type plug.

### 12. POWER-CORD PROTECTION

Power-supply cords should be routed so that they are not likely to be walked on or pinched by items placed upon or against them, paying particular attention to cords at plugs, convenience receptacles, and the point where they exit from the appliance.

PORTABLE CART WARNING  
(symbol provided by RETAC)



S3126A

### 13. LIGHTNING

To protect your unit during a lightning storm, or when it is left unattended and unused for long periods of time, unplug it from the wall outlet and disconnect the antenna or cable system. This will prevent damage to the unit due to lightning and power line surges.

### 14. POWER LINES

An outside antenna system should not be located in the vicinity of overhead power lines or other electric light or power circuits, or where it can fall into such power lines or circuits. When installing an outside antenna system, extreme care should be taken to keep from touching such power lines or circuits, as contact with them might be fatal.

### 15. OVERLOADING

Do not overload wall outlets and extension cords as this can result in a risk of fire or electric shock.

### 16. OBJECT AND LIQUID ENTRY

Do not push objects through any openings in this unit, as they may touch dangerous voltage points or short out parts that could result in fire or electric shock. Never spill or spray any type of liquid into the unit.

### 17. OUTDOOR ANTENNA GROUNDING

If an outside antenna or cable system is connected to the unit, be sure the antenna or cable system is grounded to provide some protection against voltage surges and built-up static charges, Section 810 of the National Electrical Code, ANSI/NFPA 70, provides information with respect to proper grounding of the mast and supporting structure, grounding of the lead-in wire to an antenna discharge unit, size of grounding conductors, location of antenna discharge unit, connection to grounding electrodes, and requirements for the grounding electrode.

### 18. SERVICING

Do not attempt to service this unit yourself as opening or removing covers may expose you to dangerous voltage or other hazards. Refer all servicing to qualified service personnel.

### 19. DAMAGE REQUIRING SERVICE

Unplug this unit from the wall outlet and refer servicing to qualified service personnel under the following conditions:

- a. When the power-supply cord or plug is damaged.
- b. If liquid has been spilled, or objects have fallen into the unit.
- c. If the unit has been exposed to rain or water.
- d. If the unit does not operate normally by following the operating instructions. Adjust only those controls that are covered by the operating instructions, as an improper adjustment of other controls may result in damage and will often require extensive work by a qualified technician to restore the unit to its normal operation.
- e. If the unit has been dropped or the cabinet has been damaged.
- f. When the unit exhibits a distinct change in performance, this indicates a need for service.

### 20. REPLACEMENT PARTS

When replacement parts are required, be sure the service technician uses replacement parts specified by the manufacturer or those that have the same characteristics as the original part.

Unauthorized substitutions may result in fire, electric shock or other hazards.

### 21. SAFETY CHECK

Upon completion of any service or repairs to this unit, ask the service technician to perform safety checks to determine that the unit is in proper operating condition.

### 22. HEAT

The product should be situated away from heat sources such as radiators, heat registers, stoves, or other products (including amplifiers) that produce heat.

### 23. NOTE TO CATV SYSTEM INSTALLER

This reminder is provided to call the CATV system installer's attention to Article 820-40 of the NEC that provides guidelines for proper grounding and, in particular, specifies that the cable ground shall be connected to the grounding system of the building, as close to the point of cable entry as practical.

#### EXAMPLE OF ANTENNA GROUNDING AS PER THE NATIONAL ELECTRICAL CODE

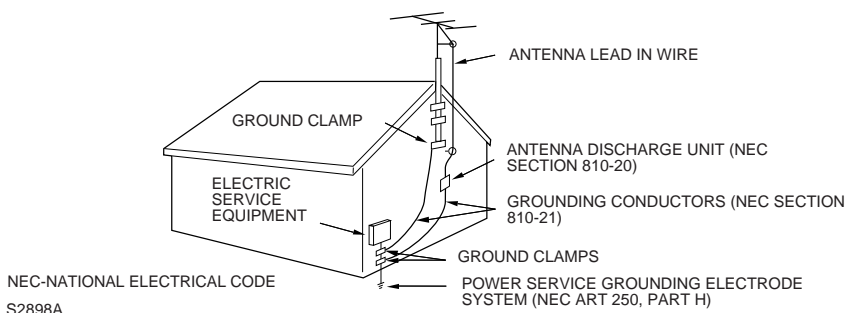



ENERGY STAR

- As an “ENERGY STAR®” partner, JVC has determined that this product or product model meets the “ENERGY STAR®” guidelines for energy efficiency.

### IMPORTANT RECYCLING INFORMATION

This product utilizes both a Cathode Ray Tube (CRT) and other components that contain lead. Disposal of these materials may be regulated in your community due to environmental considerations. For disposal or recycling information, please contact your local authorities, or the Electronic Industries Alliance: <http://www.eiae.org>

## TABLE OF CONTENTS

FEATURES .....	4	PICTURE ADJUSTMENTS .....	19
LOCATION OF CONTROLS .....	5	SOUND ADJUSTMENTS .....	19
REMOTE CONTROL .....	6	CLOSED CAPTION .....	20
ANTENNA/CATV CONNECTIONS .....	11	ON/OFF TIMER .....	21
CONNECTION TO OTHER EQUIPMENT .....	12	SLEEP TIMER button .....	22
SETTING LANGUAGE .....	13	VCR buttons .....	22
SETTING CLOCK .....	13	DVD buttons .....	22
TO MEMORIZE CHANNELS .....	14	TV/CATV switch .....	22
SETTING V-CHIP .....	15	VCR/DVD switch .....	22
TV BASIC OPERATION .....	17	TROUBLESHOOTING GUIDE .....	23
INPUT button .....	18	SPECIFICATIONS .....	Back Cover
STEREO AND SEPARATE AUDIO			
PROGRAM (SAP) .....	18		
DISPLAY button .....	18		

## FEATURES

- **Flat Picture Tube** - It reduces the influence of surrounding light resulting in outstanding image detail and clarity.
- **181 Channel Tuner** - The tuning system is capable of receiving all 68 VHF/UHF standard broadcast channels that are available in your area. When operating on a cable system, it can tune to the standard VHF channel frequencies plus up to 113 cable channel frequencies. The actual number of channels received depends upon channel reception in your area or your cable system.
- **On-Screen 3 Language Display** - Consists of channel, sleep timer, volume level, muting, text/caption indicators and picture control adjustments. These can be displayed in English, Spanish or French.
- **ON/OFF Timer** - Allows you to automatically turn on or off your TV at a set time.
- **Sleep Timer** - Operable from the remote control, this TV can be programmed up to 120 minutes to turn off automatically.
- **V-Chip** - The V-Chip function can read the rating of a TV program or movie content if the program is encoded with this information. The V-Chip will allow you to set a restriction level.
- **Picture Control Adjustments** - The On-Screen display allows precise remote control adjustment of BRIGHTNESS, COLOR, CONTRAST, SHARPNESS, TINT and COMPONENT.
- **Closed Captioned Decoder** - Displays text captions or 1/2 of full screen text on the screen for hearing impaired viewers.
- **Stereo/SAP Reception** - This TV is designed to receive stereo and separate audio program (SAP) broadcasts where available.
- **Video Input Jacks** - This unit is equipped 3 types of video input jacks. The component video in jacks and S-video in jack enable you to watch the DVD player or the video devices with high quality picture.
- **Remote Control** - You can operate your VCR, Cable Box, Satellite Dish and DVD after you have registered the 3-digit codes for their brand name.

## FRONT

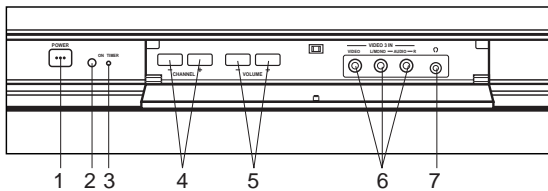
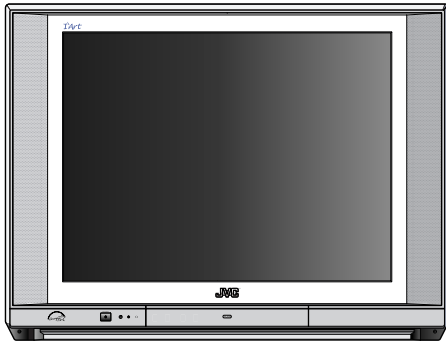

## HOW TO OPEN THE FRONT DOOR

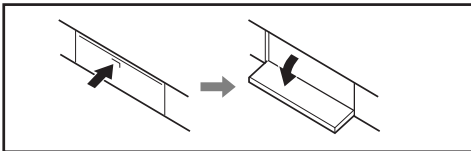

## BACK

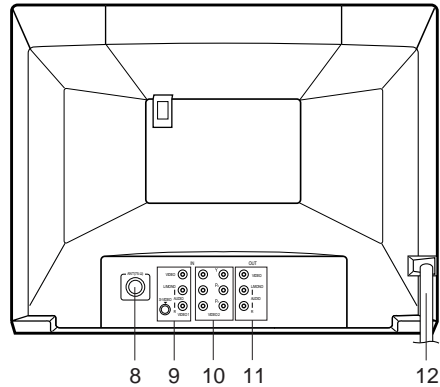

1. **POWER Button** - Press to turn the TV on or off.
2. **Remote Sensor** - Signals from the Remote Control unit are received here.
3. **ON TIMER Indicator** - This indicator lights up when the powered up. It also lights up when ON TIMER program is turned ON while power is OFF.
4. **CHANNEL +/- Buttons** - Press to select a higher or lower numbered channel set into memory.
5. **VOLUME +/- Buttons** - Press to raise or lower the volume of the sound.
6. **VIDEO 3 IN Jacks (Front)** - Audio and video signal cables from an external source can be connected here.
7. **HEADPHONES JACK** - Plug an earphone or headphones with an 1/8 miniplug into this jack for listening.
8. **VHF/UHF IN (ANT) Jack** - Connect a VHF/UHF antenna or CATV cable to this jack.

9. **VIDEO 1 IN Jacks (Rear)** - Audio and video signal cables from an external source (ex. VCR) can be connected here. If your video device has S-video out jack, connect to S-video in jack.
10. **VIDEO 2 IN Jacks** - Audio and video signal cables from an external source (ex. DVD) can be connected here.  
If you have a DVD with component video out jacks, connect to the component video in jacks. If you have a video device without the component video out, connect to video in jack.
11. **REAR AUDIO (L / R) / VIDEO OUT Jacks** - Used to output audio and video signals to a TV, amplifier or VCR.  
NOTE: This video out jack does not output the signal from component video in jacks.
12. **AC Power Cord** - Connect to a 120V, 60Hz outlet.

# REMOTE CONTROL

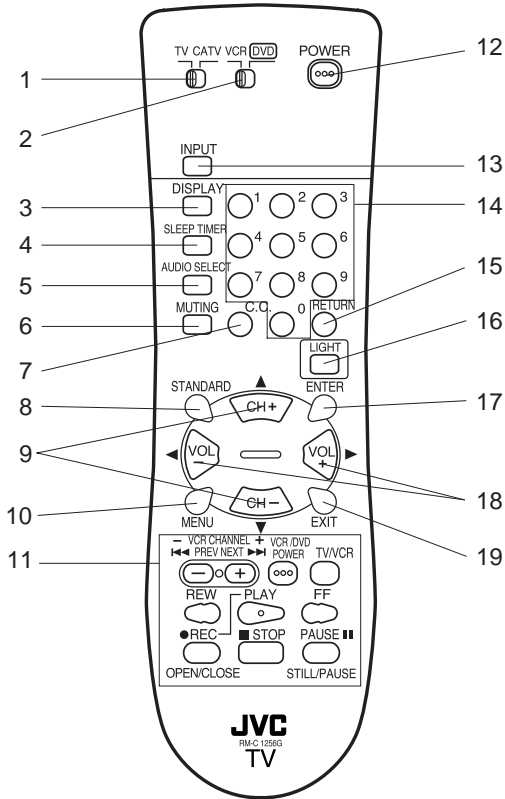

- 1. TV/CATV Switch** - Used to select the TV or Cable Box to be operated. (You can operate your cable box after you have programmed the remote control.)
- 2. VCR/DVD switch** - Used to select the VCR or DVD to be operated. (You can operate your VCR or DVD after you have programmed the remote control.)
- 3. DISPLAY Button** - Displays the current status time, channel (or Input), the present settings on the TV screen.
- 4. SLEEP TIMER Button** - Sets the TV to turn off automatically after up to 120 minutes.
- 5. AUDIO SELECT Button** - Switches sound between mono and stereo, and SAP when receiving broadcasts in stereo or SAP.
- 6. MUTING Button** - Press to turn off the sound. Press again to turn the sound back on.
- 7. C.C. (Closed Caption) Button** - Switches between Caption, Text and TV modes for Closed-Captioned programs.
- 8. STANDARD Button** - Press to reset the On-Screen picture adjustments or Audio adjustment to their factory preset positions.
- 9. CH +/- Buttons** - Press the + button to change to a higher numbered channel set into memory. Press the – button to change to a lower numbered channel set into memory. Press to select the desired item during On-Screen operations.
- 10. MENU Button** - Press to display the On-Screen menu function.
- 11. VCR or DVD Operation Buttons** - Press to operate your VCR or DVD.
- 12. POWER Button** - Press to turn the TV on or off.
- 13. INPUT Button** - Switches between the TV and external input sources.
- 14. 10-key pad** - Allows direct access to any channel of the TV, VCR or Cable box.
- 15. RETURN Button** - Switches between the present channel and the last channel selected.
- 16. LIGHT Button** - Press to turn the illumination on for CH +/- and VOL +/- buttons.
- 17. ENTER Button** - Press to enter selected setup.
- 18. VOL +/- Buttons** - Press the + button to increase, or the – button to decrease the volume level. Press to select the desired setting or arrangement during On-Screen operations.
- 19. EXIT Button** - Press to exit the On-Screen menu function.

## BATTERY INSTALLATION

1. Open the battery compartment cover.

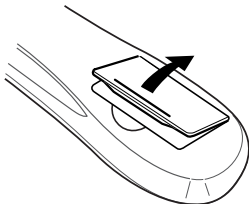

2. Install two "AA" batteries.

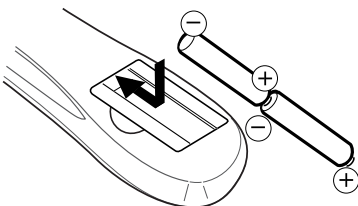

3. Replace the battery compartment cover.

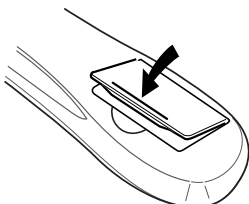

## REMOTE CONTROL BASICS

- Before you can operate the remote control, you must first install the batteries (included). See “Changing the Batteries” on this page above for instructions. (For an illustration, please see page 6.)
- Press the POWER button to turn the television on or off.
- Make sure the TV/CATV switch is set to TV. Move the switch to CATV only if you need to operate a cable box.
- Slide the VCR/DVD selector switch to VCR to control a VCR, slide to DVD to control a DVD player. Please see pages 8 to 10 for instructions on programming your remote control to operate a Cable box, VCR or DVD player.
- Press the CH + and CH – buttons to scan through the channels. Tap the CH + or CH – button to move through the channels one channel at a time.
- Press VOL + or VOL – to raise or lower the volume. An indicator bar will appear on screen to show you the television volume level.
- The CH +/- and VOL +/- buttons are also used to navigate JVC’s on screen menu system.
- You can directly access specific channels using the 10-key pad.
- This remote includes illuminated buttons for key features like CH +/- buttons, and VOL +/- buttons. Press the LIGHT button to turn the illumination on.

## CHANGING THE BATTERIES

Push down on the remote’s back cover and slide towards the bottom to remove it.

Insert two AA batteries (supplied), carefully noting the “+” and “-” markings on the batteries and on the remote control. To avoid a potential short circuit, insert the “-” end first.

Be sure to use only size AA batteries.

When batteries are installed, slide the cover back into place (until it clicks into position).

- If the remote control acts erratically, replace the batteries. Typical battery life is six months to one year. We recommend using alkaline batteries for longer battery life.

*When you change the batteries, try to complete the task within three minutes. If you take longer than three minutes, the remote control codes for your VCR, DVD, and/or Cable Box may have to be reset (pages 8-10).*

## BATTERY PRECAUTIONS

The precautions below should be followed when using batteries in this device:

1. Use only the size and type of batteries specified.
2. Be sure to follow the correct polarity when installing the batteries as indicated in the battery compartment. Reversed batteries may cause damage to the device. To avoid a potential short circuit, insert the “-” end first.
3. Do not mix different types of batteries together (e.g. Alkaline and Carbon-zinc) or old batteries with fresh ones.
4. If the device is not to be used for a long period of time, remove the batteries to prevent damage or injury from possible battery leakage.
5. Do not try to recharge batteries not intended to be recharged; they can overheat and rupture. (Follow battery manufacturer’s directions.)
6. When you change the batteries, try to complete the task within three minutes. If you take longer than three minutes, the remote control codes for your Cable Box may have to be reset (see page 8).

## EFFECTIVE DISTANCE OF THE REMOTE CONTROL TRANSMITTER

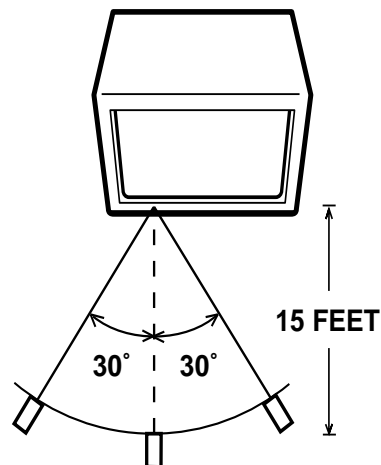

- NOTES:**
- When there is an obstacle between the TV and the transmitter, the transmitter may not operate.
  - When direct sunlight, an incandescent lamp, fluorescent lamp or any other strong light shines on the Remote sensor of the TV, the remote operation may be unstable.



## REMOTE PROGRAMMING

### Setting the CATV, VCR and DVD Codes

You can program your remote to operate your cable box, satellite receiver, VCR or DVD player by using the instructions and codes listed below. If the equipment does not respond to any of the codes listed below or to the code search function, use the remote control supplied by the manufacturer.

#### Cable Box or Satellite setup

The remote control is programmed with CATV and/or Satellite codes for power on, power off, channel up, channel down, and 10 key operation.

- 1) Find the CATV/Satellite brand from the list of codes shown below.
- 2) Slide the 2-way selector switch to "CATV".
- 3) Press and hold down the DISPLAY button.
- 4) With the DISPLAY button held down, enter the first code number listed using the 10 key pad.
- 5) Release the DISPLAY button.
- 6) Confirm the operation of the Cable Box/Satellite receiver.
  - If your CATV or Satellite box does not respond to the first code, try the others listed. If it does not respond to any code, try the Search Codes Function as shown below.

Cable Box	CODES	Cable Box	CODES
ABC	024	Pulsar	051, 032
Archer	032, 025	Puser	032
Cableview	051, 032	RCA	061, 070
Citizen	022, 051	Realistic	032
Curtis	058, 059	Regal	058, 064, 040, 041, 042, 045, 068
Diamond	024, 032, 025	Regency	034
Eagle	029	Rembrandt	037, 032, 051, 038
Eastern	034	Samsung	051
GC Brand	032, 051	Scientific Atlanta	057, 058, 059
Gemini	022, 043	SLMark	051, 047
General Instrument	065, 024, 025, 026, 027, 020, 021, 022, 057, 023	Sprucer	051, 056
Hamlin	040, 041, 042, 045, 058, 064	Stargate	032, 051
Hitachi	049, 024	Telecaption	067
Jerrold	065, 024, 025, 026, 027, 020, 021, 022, 057, 023	Television	047, 051
Macom	049, 050, 051, 054	Texscan	044
Magnavox	033	Tocom	035, 036, 066
Memorex	030	Toshiba	050
Movietime	032, 051	Unika	032, 025
Oak	039, 037, 048	Universal	022, 032
Panasonic	055, 056, 060, 071	Videoway	052
Paragon	063	Viewstar	029, 030
Philips	028, 029, 030, 052, 053, 031, 069	Zenith	063, 046
Pioneer	047, 062	Zenith/Drake Satellite	046

Digital Satellite Systems	CODES	Digital Satellite Systems	CODES
Echostar	100, 113, 114	Philips	102, 103
Express VU	100, 113	Primestar	108
G.E.	106	Proscan	106, 109, 110
G.I.	108	RCA	106, 109, 110
Gradiente	112	Sony	107
Hitachi	104, 111	Star Choice	104, 108
HNS (Hughes)	104	Toshiba	101
Pranasonic	105	Uniden	102, 103

#### Cable/Satellite Search Codes Function:

- 1) Slide the 2-Way Mode Selector switch to CATV.
- 2) Press the TV POWER and RETURN buttons. Hold for at least three seconds and release.
- 3) Press TV POWER, see if the CATV or Satellite box responds.
- 4) If there was a response, press RETURN. The operating codes are now set. If there was no response, repeat Step 3. If you repeat Step 3 a total of 52 times without a response, use the remote control which came with the equipment.
- 5) Press RETURN to exit.



## VCR setup

The remote control is programmed with VCR codes for power on, power off, play, stop, fast-forward, rewind, pause, record, channel up, and channel down operation.

- 1) Find the VCR brand from the list of codes shown below.
- 2) Slide the first 2-way selector switch to "TV" and the other 2-way selector switch to "VCR".
- 3) Press and hold down the DISPLAY button.
- 4) With the DISPLAY button held down, enter the first code number listed with the 10 key pad.
- 5) Release the DISPLAY button.
- 6) Confirm the operation of the VCR.
  - If your VCR does not respond to the first code, try the others listed. If it does not respond to any code, try the Search Codes Function as shown below.
  - Some manufacturer's VCR's may not respond to the TV/VCR button, even if other buttons work properly.
  - To record, hold down the REC button on the remote and press PLAY.

VCRs	CODES	VCRs	CODES
Admiral	035	Optimus	028, 021, 035, 064
Aiwa	027, 032, 095	Orion	026, 020
Akai	029, 072, 073, 074	Panasonic	023, 024, 021, 022
Audio Dynamic	003, 005	Penney	024, 058, 045, 063, 003, 004, 005, 093
Bell & Howell	063, 071	Pentax	058, 005, 045, 093
Broksonic	020, 026, 094	Philco	031, 024, 027, 023, 026, 020, 043
Canon	023, 025	Philips	031, 023, 024, 086
CCE	043	Pioneer	023
Citizen	064	Proscan	045, 058, 023, 024, 031, 046, 059, 060, 033, 087, 093
Craig	063, 029, 064	Quasar	021, 022, 023, 024
Curtis Mathes	045, 024, 027, 093	Radio Shack	033, 024, 063, 036, 067, 040, 027
Daewoo	043, 059, 024, 092	RCA	033, 045, 058, 023, 024, 031, 046, 059, 060, 083, 084, 085, 087, 093
DBX	003, 004, 005	Realistic	024, 063, 036, 067, 040, 027
Dimensia	045, 093	Samsung	037, 060, 062, 033, 089
Emerson	043, 026, 077, 061, 025, 042, 020, 076	Samtron	089
Fisher	063, 066, 067, 065, 071, 091	Sansui	003, 026, 020, 052
Funai	027, 026, 020, 000	Sanyo	063, 067, 091, 071
G.E.	033, 045, 024	Scott	059, 060, 062, 067, 038, 040, 047, 048, 026, 020
Go Video	037, 051, 049, 050, 089	Sears	063, 064, 065, 066, 058, 000, 001
Goldstar	064	Shintom	075
Gradiente	083, 084, 081, 000, 001	Sharp	035, 036, 080, 088
Hitachi	023, 045, 058, 027, 081, 093	Signature 2000	027, 035
Instant Replay	024, 023	Singer	075
Jensen	003	Sony	028, 029, 030, 053, 054, 055
JVC	000, 001, 002, 003, 004, 005	SV 2000	027
Kenwood	003, 004, 064, 005	Sylvania	031, 023, 024, 027
LXI	027, 064, 058, 065, 066, 063, 067	Symphonic	027, 081
Magnavox	031, 023, 024, 086	Tashiro	064
Marantz	003, 004, 005	Tatung	003, 004, 005
Marta	064	Teac	003, 004, 027, 005
Memorex	024, 067	Technics	021, 022, 023, 024
MGA	038, 040, 047, 048, 041, 042	Teknika	024, 027, 070
Minolta	058, 045, 093	Toshiba	059, 046, 079
Mitsubishi	038, 040, 047, 048, 041, 042, 078, 090	Vector Research	005
Multitech	047, 027, 062	Wards	035, 036, 067, 044, 064
NEC	003, 004, 005, 000	Yamaha	063, 003, 004, 005
Olympic	024, 023	Zenith	044, 082, 064, 094

## VCR Search Codes Function:

- 1) Slide the first 2-way selector switch to "TV" and the other 2-way selector switch to "VCR".
- 2) Press the VCR POWER and RETURN buttons. Hold for at least three seconds and release.
- 3) Press VCR POWER, see if the VCR responds.
- 4) If there was a response, press RETURN. The operating codes are now set. If there was no response, repeat Step 3. If you repeat Step 3 a total of 80 times without a response, use the manufacturer's remote control which came with the VCR.
- 5) Press RETURN to exit.

## DVD setup

The remote control is programmed with DVD codes for power on, power off, play, stop, fast-forward, rewind, previous chapter, next chapter, tray open/close, and still/pause operation.

- 1) Find the DVD player brand from the list of codes shown below.
- 2) Slide the first 2-way selector switch to "TV" and the other 2-way selector switch to "DVD".
- 3) Press and hold down the DISPLAY button.
- 4) With the DISPLAY button held down, enter the first code number listed with the 10 key pad.
- 5) Release the DISPLAY button.
- 6) Confirm the operation of the DVD player.
  - If your DVD player does not respond to the first code, try the others listed. If it does not respond to any code, try the Search Codes Function as shown below.
  - After you program your remote, some DVD buttons may not work properly. If some buttons do not work properly, use the remote control which came with your DVD player.

DVD Player	CODES	DVD Player	CODES
Aiwa	043	Raite	033
Apex	040	RCA	021, 026
Denon	020, 037	Sampo	034
Hitachi	030, 031	Samsung	030
JVC	000	Sharp	028
Kenwood	035	Sylvania	038
Konka	039	Sony	024, 045, 046, 047
Mitsubishi	025	Technics	020
Onkyo	041	Toshiba	023
Oritron	044	Wave	042
Panasonic	020	Yamaha	020
Philips	023, 036	Zenith	027, 032
Pioneer	022		

## DVD Player Search Codes Function:

- 1) Slide the first 2-way selector switch to "TV" and the other 2-way selector switch to "DVD".
- 2) Press the DVD POWER and RETURN buttons. Hold for at least three seconds and release.
- 3) Press DVD POWER, see if the DVD player responds.
- 4) If there was a response, press RETURN. The operating codes are now set. If there was no response, repeat Step 3. If you repeat Step 3 a total of 30 times without a response, use the manufacturers remote control which came with the DVD player.
- 5) Press RETURN to exit.

# ANTENNA/CATV CONNECTIONS

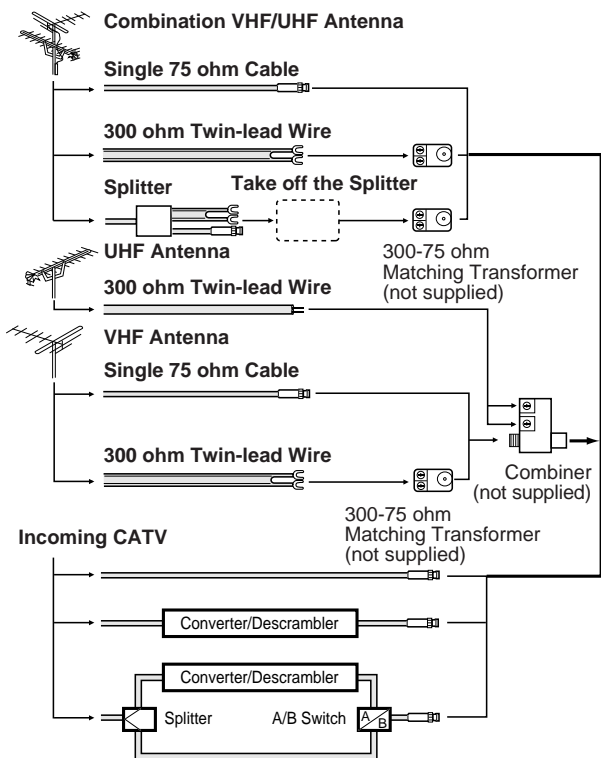

## Combination VHF/UHF Antenna (Single 75 ohm Cable or 300 ohm Twin-lead Wire)

Connect the 75 ohm cable from a combination VHF/UHF antenna to the Antenna Jack. If your combination antenna has a 300 ohm Twin-lead Wire, use the 300-75 ohm Matching Transformer (not supplied).

## Combination VHF/UHF Antenna (Separate VHF and UHF 300 ohm Twin-leads)

Connect the UHF Twin-lead Wire to a Combiner (not supplied). Connect the VHF Twin-lead to the 300-75 ohm Matching Transformer (not supplied). Attach the Transformer to the Combiner. Attach the Combiner to the Antenna Jack.

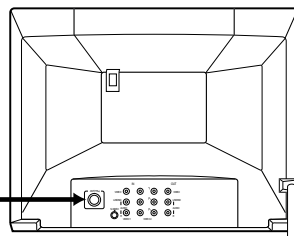

Illustration of AV-24F704

This television has an extended tuning range and can tune most cable channels without using a cable company supplied converter box. Some cable companies offer "premium pay channels" in which the signal is scrambled. Descrambling these signals for normal viewing requires the use of a descrambler device which is generally provided by the cable company.

## Separate VHF/UHF Antennas

Connect the 75 ohm Cable from the VHF antenna and the UHF antenna Twin-lead to a combiner (not supplied). Attach the Combiner to the Antenna Jack.

**NOTE:** If your VHF antenna has a Twin-lead Wire, use the 300-75 ohm Matching Transformer (not supplied), then connect the Transformer to the Combiner.

## For Subscribers to Basic Cable TV Service

For basic cable service not requiring a Converter/Descrambler box, connect the CATV 75 ohm Coaxial Cable directly to the Antenna Jack on the back of the television.

## For Subscribers to Scrambled Cable TV Service

If you subscribe to a cable service which requires the use of a Converter/Descrambler box, connect the incoming cable to the Converter/Descrambler box and connect the output of the box to the Antenna Jack on the back of the television. Follow the connections shown left. Set the television to the output of the Converter/Descrambler box (usually channel 3 or 4) and use the Converter/Descrambler box to select channels.

## For Subscribers to Unscrambled Basic Cable with Scrambled Premium Channels

If you subscribe to a cable service in which basic cable channels are unscrambled and premium channels require the use of a Converter/Descrambler box, you may wish to use a two-set signal splitter (sometimes called a "two-set coupler") and an A/B Switch box from the cable installer or an electronics supply store. Follow the connections shown left. With the switch in the "B" position, you can directly tune any unscrambled channels on your TV. With the switch in the "A" position, tune your TV to the output of the Converter/Descrambler box (usually channel 3 or 4) and use the box to tune scrambled channels.

# CONNECTION TO OTHER EQUIPMENT

The exact arrangement you use to interconnect various video and audio components to the TV is dependent on the model and features of each component. Check the User's Guide provided with each component for the location of video and audio inputs and outputs.

The connection diagrams in the following are offered as suggestions. You may need to modify them to accommodate your particular assortment of components. The diagrams are intended to show component video and audio interconnections only.

Press the INPUT button to select the AV mode to use the TV as a monitor.  
Operate your VCR as usual.

## TV/AV SELECTION

If you connect the TV to VCR, camcorder, TV game or DVD you can select by pressing the INPUT button.

Press the INPUT button repeatedly to select the desired mode.

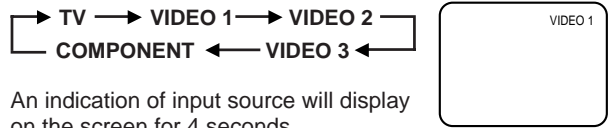

- 1. To connect the TV to a VCR**  
(ex. Use VIDEO 1 IN jacks to connect it.)

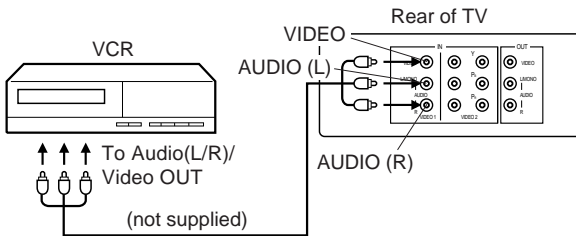

- Select "VIDEO 1" by pressing the INPUT button to display the VCR picture.

- 3. To connect the TV to a camcorder**  
To playback from the camcorder, connect the camcorder to the TV as shown.

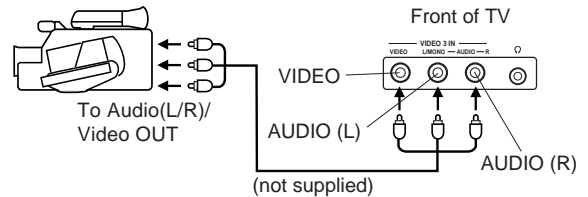

- Select "VIDEO 3" by pressing the INPUT button to display the camcorder picture.

- 2. To connect the TV to a VCR with an S-VIDEO jack**

If you connect a VCR with an S-video jack to the S-VIDEO jack on the rear of TV, you must also connect the audio cables to the AUDIO IN (VIDEO 1) jacks on the rear of the TV. The S-video cable only carries the video signal. Audio signal is separate.

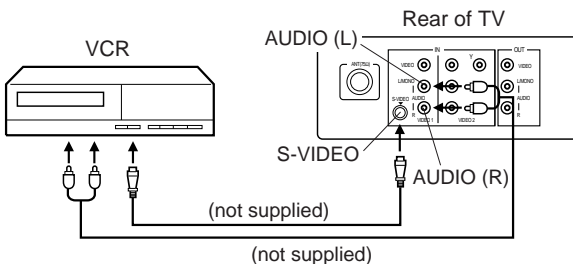

**NOTE:** When the S-video cable and the video cable are connected to each jack at the same time, the S-video cable takes precedence over the video cable.

- 4. To connect the TV to a DVD with COMPONENT VIDEO OUT Jacks.**

If you connect a DVD with the COMPONENT VIDEO OUT jacks to the COMPONENT VIDEO IN (Y, PB, PR) jacks on the rear of TV, you must also connect the audio cables to the AUDIO IN (VIDEO 2 IN) jacks on the rear of the TV.

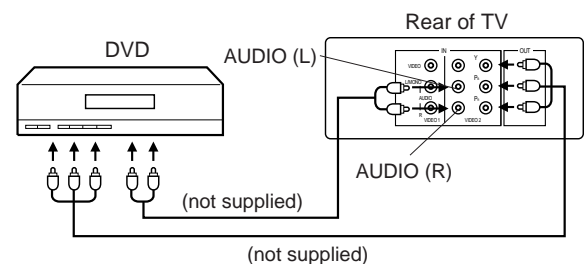

- Select "COMPONENT" by pressing the INPUT button to display the DVD picture.
- If you have a DVD without COMPONENT VIDEO OUT jacks, connect the video cable to VIDEO IN (VIDEO 2 IN) jack. In this case, select "VIDEO 2" by pressing the INPUT button to display the DVD picture.

# SETTING LANGUAGE

This TV can display the channel number, on-screen displays and picture adjustments on the screen in English, Spanish or French.

On-screen language selection (step 3) will automatically appear on the screen when you press the MENU button initially. Select the language you prefer first, then proceed with the other menu options.

1 Press the MENU button.

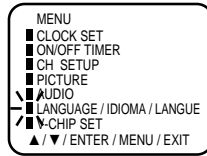

2 Press the CH + (▲) or – (▼) button to select the LANGUAGE mode, then press the ENTER button.

3 Press the CH + (▲) or – (▼) button until the “▶” indicator points to the desired language: English (ENGLISH), Spanish (ESPAÑOL) or French (FRANCAIS), then press the ENTER button.

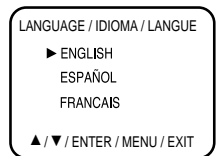

4 Press the EXIT button.

## NOTE:

If Spanish or French is chosen, the Closed Caption indicators will be in the selected language, but the Closed Caption text will not be affected by the language selection.

# SETTING CLOCK

You must set the time manually for DISPLAY and ON/OFF TIMER.

1 Press the MENU button.

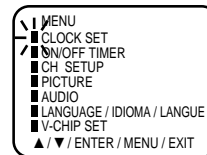

2 Press the CH + (▲) or CH – (▼) button until the indicator next to “CLOCK SET” begins to flash, then Press the ENTER button.

4 Press the CH + (▲) or CH – (▼) button to set the minute.

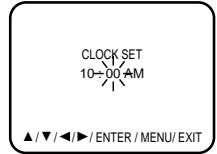

5 Press the EXIT button.

3 Press the CH + (▲) or CH – (▼) button to set the hour, then press the VOL + (▶) button.

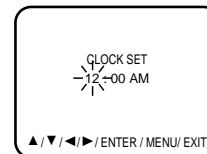

## NOTES:

- After a power failure or disconnection of the power plug, the time display will be lost. In this case, set present time again.
- When you set the minute, you can change in 10-minutes by holding down the CH + (▲) or CH – (▼) button.

# TO MEMORIZE CHANNELS

This TV is equipped with a channel memory feature which allows channels to skip up or down to the next channel set into memory, skipping over unwanted channels. Before selecting channels, they must be programmed into the TV's memory. In addition to normal VHF and UHF channels, this TV can receive up to 113 Cable TV channels. To use this TV with an antenna, set the TV/CATV menu option to the TV setting. When shipped from the factory, this menu option is in the CATV setting.

## TV/CATV SELECTION

- 1 Press the MENU button.
- 2 Press the CH + (▲) or – (▼) button until the indicator next to “CH SETUP” begins to flash, then press the ENTER button.
- 3 Press the CH + (▲) or – (▼) button until the indicator next to “TV/CATV” begins to flash.

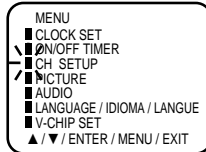

- 4 Press the VOL + (▶) or – (◀) button to select the “TV” or “CATV” mode. The arrow indicates the selected mode.

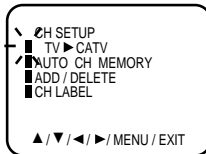

- 5 Press the EXIT button.

**NOTE:** Contact your cable company to determine the type of cable system used in your area.

## AUTOMATIC CHANNEL MEMORY

- 1 Press the MENU button.
- 2 Press the CH + (▲) or – (▼) button until the indicator next to “CH SETUP” begins to flash, then press the ENTER button.
- 3 Press the CH + (▲) or – (▼) button until the indicator next to “AUTO CH MEMORY” begins to flash, then press the ENTER button. The TV will begin memorizing all the channels available in your area.
- 4 Press the EXIT button.

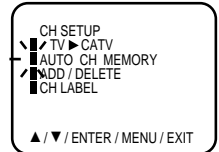
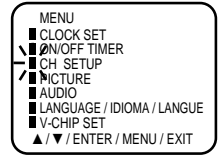

## TO ADD/DELETE CHANNELS

- 1 Press the MENU button.
- 2 Press the CH + (▲) or – (▼) button until the indicator next to “CH SETUP” begins to flash, then press the ENTER button.
- 3 Press the CH + (▲) or – (▼) button until the indicator next to “ADD/DELETE” begins to flash, then press the ENTER button.

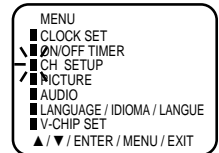

- 4 Select the desired channels to be added or deleted using the 10-key pad (0-9) or the CH + or – button.

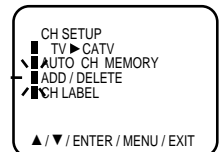

- 5 Press the VOL + (▶) or – (◀) button to select “ADD” or “DELETE”.

If an unmemorized channel was selected (step 4), the channel indication will be red. Press the VOL + (▶) or – (◀) button if you wish to ADD the unmemorized channel. The channel indicator will change from red to green when a channel is added and the channel will be memorized. If a memorized channel was selected (step 4), the channel indication will be green.

Press the VOL + (▶) or – (◀) button if you wish to DELETE the channel from memory. The channel indicator will change from green to red when a channel is deleted. Repeat Steps 4 and 5 for each channel to be added or deleted.

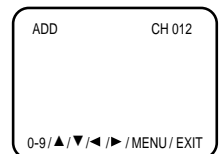

- 6 Press the EXIT button after adding or deleting all of the desired channels, to return to normal TV viewing.

## CH LABEL

You can label every channel up to 4 characters.

Channel labels will appear over the channel number display each time you select a channel.

- 1 Select a channel you want to label by pressing the 10-key pad or CH + or – button.
- 2 Press the MENU button.
- 3 Press the CH + (▲) or – (▼) button until the indicator next to “CH SETUP” begins to flash, then press the ENTER button.
 

MENU

  - CLOCK SET
  - ON/OFF TIMER
  - CH SETUP
  - PICTURE
  - AUDIO
  - LANGUAGE / IDIOMA / LANGUE
  - V-CHIP SET
  - ▲ / ▼ / ENTER / MENU / EXIT
- 4 Press the CH + (▲) or – (▼) button until the indicator next to “CH LABEL” begins to flash, then press the ENTER button.
 

CH SETUP

  - TV ▶ CATV
  - AUTO CH MEMORY
  - ADD / DELETE
  - CH LABEL
  - ▲ / ▼ / ENTER / MENU / EXIT
- 5 Press the VOL + (▶) or – (◀) button to select "SET" or "CLEAR". Select "SET" in case you have a channel to label or change. Select "CLEAR" in case you have a channel to delete. Then press the ENTER button.
 

CH LABEL : CH 012

  - SET/CLEAR
  - ▶ SET CLEAR
  - LABEL ----
  - ▲ / ▼ / ◀ / ▶ / ENTER / MENU / EXIT

- 6 Go to step 7 when you select the “SET”. Go to step 9 when you select the “CLEAR”.
- 7 Now the bar for the first space is flashing. Press the VOL + (▶) or – (◀) button to enter a character in the first space. Press the button repeatedly until the character you want appears on the screen. Then press the ENTER button.
 

CH LABEL : CH 012

  - SET/CLEAR
  - ▶ SET
  - LABEL - - - -
  - ▲ / ▼ / ◀ / ▶ / ENTER / MENU / EXIT

**NOTE:**

The character will change as below.

– ◀ → 0 ◀ → ... ◀ → 9 ◀ → A ◀ → ...  
 ◀ → Z ◀ → SPACE ◀ → + ◀ → –

- 8 Repeat step 7 to enter the rest of the characters from second to fourth.
- 9 Press the ENTER button to register.
- 10 Press the EXIT button.

## SETTING V-CHIP

This TV is fitted with a V-CHIP controller which provides you with channel viewing access controls and restrictions. This function is to prevent your children from watching violence or sexual scenes that may be harmful.

- 1 Press the MENU button and press the CH + (▲) or – (▼) button to select the “V-CHIP SET” option, then press the ENTER button.
 

MENU

  - CLOCK SET
  - ON/OFF TIMER
  - CH SETUP
  - PICTURE
  - AUDIO
  - LANGUAGE / IDIOMA / LANGUE
  - V-CHIP SET
  - ▲ / ▼ / ENTER / MENU / EXIT
- 2 Enter your password (4 digits) using the 10-key pad (0-9). In the event of entering incorrect password press the VOL – (◀) button. Then press the ENTER button.
 

V-CHIP SET

NEW PASSWORD : \*\*\*\*

0-9 / ◀ / ENTER / MENU / EXIT

  - After registration of password, step 3 will not appear.
- 3 Enter the same password for confirmation, then press the ENTER button.
 

V-CHIP SET

CONFIRM PASSWORD : \*\*\*\*

0-9 / ◀ / ENTER / MENU / EXIT
- 4 Press the CH + (▲) or – (▼) button to select the V-CHIP option. Press the VOL + (▶) or – (◀) button to select the ON.
 

V-CHIP SET

  - V-CHIP : OFF
  - US TV RATING : OFF
  - MOVIE RATING : OFF
  - CAN ENG RATING : OFF
  - CAN FRE RATING : OFF
  - CHANGE PASSWORD
  - ▲ / ▼ / ◀ / ▶ / MENU / EXIT
- 5 For U.S.: Press the CH + (▲) or – (▼) button to select the “US TV RATING” or “MOVIE RATING” option. For Canadian: Press the CH + (▲) or – (▼) button to select the “CAN ENG RATING” or “CAN FRE RATING” option.
 

V-CHIP SET

  - V-CHIP : ON
  - US TV RATING : OFF
  - MOVIE RATING : OFF
  - CAN ENG RATING : OFF
  - CAN FRE RATING : OFF
  - CHANGE PASSWORD
  - ▲ / ▼ / ◀ / ▶ / MENU / EXIT
- 6 Press the VOL + (▶) or – (◀) button to select the desired rating for the applicable video or TV channel.
 

V-CHIP SET

  - V-CHIP : ON
  - US TV RATING : TV-14
  - MOVIE RATING : OFF
  - CAN ENG RATING : OFF
  - CAN FRE RATING : OFF
  - CHANGE PASSWORD
  - DISPLAY TO SET CONTENTS
  - ▲ / ▼ / ◀ / ▶ / MENU / EXIT
- 7 Press the EXIT button.



## for U.S: TV RATING

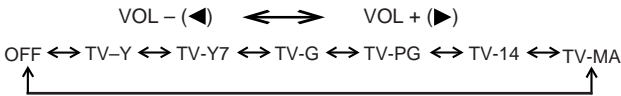

TV-Y : all children  
 TV-Y7 : 7 years old and above  
 TV-G : childrens program  
 TV-PG : parental guidance  
 TV-14 : 14 years old and above  
 TV-MA : 17 years old and above

When you select TV-Y7, TV-PG, TV-14 or TV-MA, press the DISPLAY button to explain the rating.  
 Press the CH + (▲) or - (▼) button to select the desired rating you want. Press the VOL + (▶) or - (◀) button to select the setting ON or OFF. If you want to back to V-CHIP SET menu, press the MENU button.

## for Canadian: CAN ENG RATING



E : Exempt  
 C : Programming Intended for Children  
 C8+ : Programming Intended for Children 8 and Over  
 G : General Audience  
 PG : Parental Guidance  
 14+ : 14 Years and Older  
 18+ : Adult

## MOVIE RATING



G : all ages  
 PG : parental guidance  
 PG-13 : parental guidance less than 13 years old  
 R : under 17 years old  
 NC-17 : 17 years old and above  
 X : adult only

## CAN FRE RATING

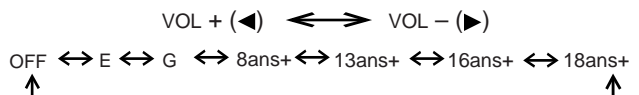

E : Exemptées.  
 G : Général.  
 8ans+ : Général-Déconseillé aux jeunes enfants.  
 13ans+ : Cette émission peut ne pas convenir aux enfants de moins de 13 ans.  
 16ans+ : Cette émission ne convient pas aux moins de 16 ans.  
 18ans+ : Cette émission est réservée aux adultes.

### NOTES:

- If you want to change password, follow steps 1 and 2 and select "CHANGE PASSWORD" option then enter your new password.
- The V-Chip function is activated only on programs and tapes that have the rating signal.
- Once you block a program using the V-Chip function, the blocked program cannot be watched based on the content of the show. When the program starts, the "IF YOU CANCEL PROTECT, INPUT PASSWORD" will appear on the screen. When you want to release the V-Chip temporarily, enter the password.  
 If you change the channel or turn off and on the TV while releasing the V-Chip temporarily, the V-Chip setting will be resumed.
- When you watch the TV from the cable box or the VCR with the RF Modulator, then you release the V-Chip temporarily, the V-Chip setting will not be resumed until you turn off the TV. The TV channel is not used in this case.
- When changing the channel with the cable box or the VCR, approximately 10 seconds will pass until the program appears.
- When you dislocated or lost the password, you can cancel the existing password by the following procedure:
  - Press VOLUME - button of main unit.
  - Keep pressing VOLUME - button of main unit and press "0" key of remote control simultaneously for a few seconds.

# TV BASIC OPERATION

Before operate your TV select TV position of the TV/CATV switch on the remote to control the TV with the remote.

1 To turn on the TV, press the POWER button.

2 The VOLUME can be adjusted to a desired level by pressing the VOL (VOLUME) + or – button.

Adjust the volume level by pressing the VOLUME + or – button. The volume level will be indicated on the screen by green bar. As the volume level increases, so do the number of bar. If the volume decreases, the number of green bar also decreases.

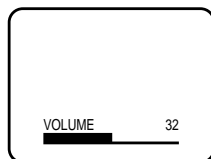

The sound level will be indicated on the TV screen by green bars and a number. As the sound level increases, so do the number of bars and the number on the screen. The same is true for decreasing the level.

3 Set the TV/CATV menu option to the appropriate position. When shipped from the factory, this menu option is in the CATV setting. See "TO MEMORIZE CHANNELS".

TV	- VHF/UHF channels
CATV	- CABLE TV channels

4 **CH (CHANNEL) + and – buttons**  
Press and release the CH (CHANNEL) + or – button. The channel automatically stops at the next channel set into memory.

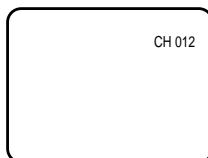

For proper operation, before selecting channels, they should be set into the TV's memory. See "TO MEMORIZE CHANNELS".

## RETURN button

Returns to the channel viewed just before the channel currently onscreen.

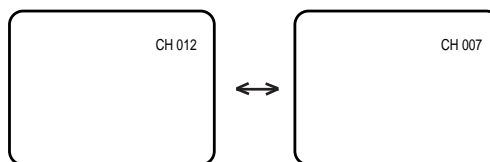

## MUTING button

The MUTING button instantly turns the volume down completely when you press it.

Press MUTING button and the volume level will instantly go to zero. To restore the volume to its previous level, press MUTING button again.



## 10-key pad (0-9)

Press these buttons to select a channel. The channel number will appear on the upper right corner of the TV screen. If an invalid channel number is selected, the display will revert to the original channel.

## TV Mode Direct Channel Selection

When the TV/CATV menu option is in the TV position, all channels can be instantly selected by using two buttons. (For example, to select channel 2, press "0", then "2". If you press only "2", channel selection will be delayed for a few seconds). For channels 10 and above, press the 2 digits in order.

## CATV Mode Direct Channel Selection

When the TV/CATV menu option is in the CATV position, channels can be selected as follows:

CH. 1-9 Press "0" twice, then 1-9 as needed. Example, to select channel 2, press "002".

CH. 10-12 Press "0", then remaining 2 digits. Example, to select channel 12, press "012".

CH. 13-99 Press the 2 digits in order. Example, to select channel 36, press "36".

CH. 100-125 Press the 3 digits in order. Example, to select channel 120, press "120".

**NOTE:** If the station being viewed stops broadcasting, the TV will automatically shut off after 15 minutes.

# INPUT button

Selects the signal input source for the television or Video1,2,3 or Component for video devices like VCR's, DVD players, or camcorders.



The input source changes as below.

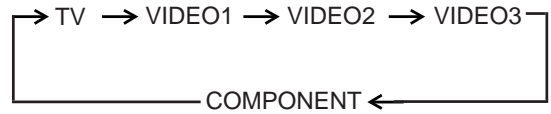

# STEREO AND SEPARATE AUDIO PROGRAM (SAP)

The TV is equipped with a feature known as Multi-channel TV Sound or MTS. MTS broadcasts greatly enhance TV viewing by bringing you programs with high fidelity stereo sound. MTS also provides an extra channel called the Separate Audio Program or SAP which broadcasters can use to transmit a second language for bilingual transmission or for other purposes.

## LISTENING TO STEREO SOUND

When the TV is turned on or a channel selection is made, make certain the STEREO appears on the screen. This means that Stereo broadcasting is available. You can enjoy stereo sound from the left and right speakers.

- When Mono broadcasting is received, no indication is displayed.
- If the broadcast signal is not strong enough or clear stereo sound is not available, press the AUDIO SELECT button to change to mono sound. The noise should be eliminated. Press it again to return to the stereo sound.

## LISTENING TO SAP (SEPARATE AUDIO PROGRAM)

When the TV is turned on or a channel selection is made, make certain the SAP appears on the screen. This means that the "Separate Audio Program" broadcasting is available.

## TO SELECT DESIRED SOUND

Press the AUDIO SELECT button to select the desired sound.

## MONO+SAP BROADCASTING

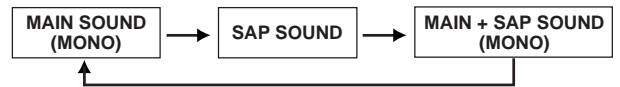

## STEREO+SAP BROADCASTING

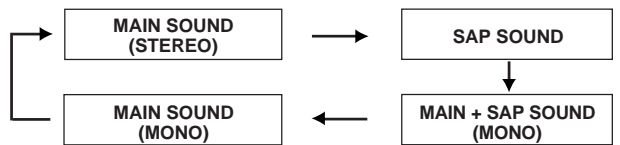

# DISPLAY button

Press the DISPLAY button to display the current informations on the screen.

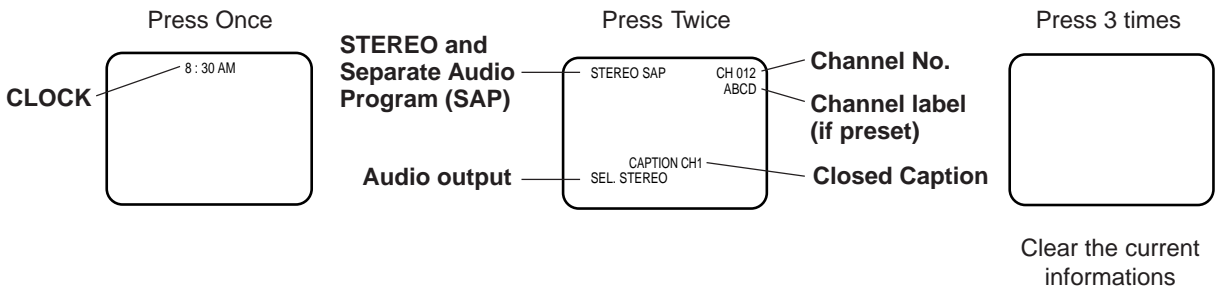

# PICTURE ADJUSTMENTS

You can adjust the settings for color, sharpness, contrast, brightness, tint and component.

- 1 Press the MENU button.
- 2 Press the CH + (▲) or – (▼) button until the indicator next to “PICTURE” begins to flash, then press the ENTER button.

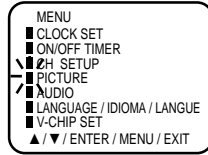

- 3 Press the CH + (▲) or – (▼) button repeatedly to select the item you want to adjust.



- 4 Press the VOL + (▶) or – (◀) button to adjust the setting.

	+	–
<b>BRIGHTNESS</b>	increase brightness	decrease brightness
<b>CONTRAST</b>	increase contrast	decrease contrast
<b>COLOR</b>	brilliant color	pale color
<b>TINT</b>	greenish color	reddish color
<b>SHARPNESS</b>	makes picture clearer	makes picture softer
<b>COMPONENT</b>	be best picture for DVD	indicate video device except DVD

## TO RETURN TO INITIAL SETTING

Press the STANDARD button while the picture adjusting mode appears on the screen (except the adjusting component).

**NOTE:** The on-screen display will disappear 6 seconds after finishing an adjustment. The settings can only be adjusted when they are displayed on the TV screen.

# SOUND ADJUSTMENTS

You can adjust the setting for bass, treble, balance, stable sound and hyper surround.

- 1 Press the MENU button.
- 2 Press the CH + (▲) or – (▼) button until the indicator next to “AUDIO” begins to flash, then press the ENTER button.

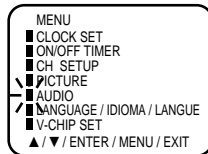

- 3 Press the CH + (▲) or – (▼) button repeatedly to select the item you want to adjust.

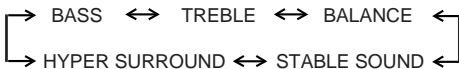
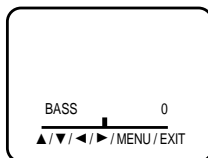

- 4 Press the VOL + (▶) or – (◀) button to adjust the setting.

	+	–
<b>BASS</b>	makes the bass sound stronger	makes the bass sound weaker
<b>TREBLE</b>	makes the treble sound stronger	makes the treble sound weaker
<b>BALANCE</b>	makes the output level of right speaker stronger	makes the output level of left speaker stronger
<b>STABLE SOUND</b>	STABLE SOUND “ON”	STABLE SOUND “OFF”
<b>HYPER SURROUND</b>	HYPER SURROUND “ON”	HYPER SURROUND “OFF”

## HYPER SURROUND FEATURE

The HYPER SURROUND feature expands the audio listening field wider and deeper to create exceptional sound quality from the TV’s speakers. The feature uses stereo signals from a TV broadcast or video input.

## TO RETURN TO INITIAL SETTING

Press the STANDARD button while the sound adjusting mode appears on the screen.

## STABLE SOUND FEATURE

When the loud sound is made, the stable sound feature automatically lower the sound.

**NOTE:** The on-screen display will disappear 6 seconds after finishing an adjustment. The settings can only be adjusted when they are displayed on the TV screen.

# CLOSED CAPTION

---

## WHAT IS CLOSED CAPTIONING?

This television has the capability to decode and display Closed Captioned television programs. Closed Captioning will display text on the screen for hearing impaired viewers or it will translate and display text in another language.

## TO VIEW CLOSED CAPTIONS

Press the C.C. button on the remote control to switch between normal TV and the two Closed Caption Modes (Captions and 1/2 of Full Screen Text).

**Captions:** This Closed Caption Mode will display text on the screen in English or another language. Generally, Closed Captions in English are transmitted on Captions Channel 1 and Closed Captions in other languages are transmitted on Captions Channel 2.

The Captions will appear in places on the screen where they will least interfere with the picture, usually on the bottom of the screen. News programs will usually show three-line Closed Captions which scroll onto the screen.

Most other shows provide two or three lined Captions placed near the character who is speaking so the viewer can follow the dialogue. Words in italics or underlined describe titles, words in foreign languages or words requiring emphasis. Words that are sung usually appear enclosed by musical notes.

**Text:** The Text Closed Caption Mode will usually fill 1/2 of full screen with a programming schedule or other information. After selecting a Closed Caption Mode, it will stay in effect until it is changed, even if the channel is changed. If the Captions signal is lost due to a commercial or a break in the signal, the Captions will reappear when the signal is received again. If the channels are changed, the Captions will be delayed approximately 10 seconds.

For television programs broadcasting with Closed Captions, look in your TV guide for the Closed Captions symbol (CC).

- When activating the Closed Captioned Decoder, there will be a short delay before the Closed Captioned text appears on the screen.
- Closed Captioned text is only displayed in locations where it is available.
- If no caption signal is received, no captions will appear, but the television will remain in the Caption Mode.
- Misspellings or unusual characters may occasionally appear during Closed Captioning. This is normal with Closed Captioning, especially with live programs. This is because during live programs, captions are also entered live. These transmissions do not allow time for editing.
- When Captions are being displayed, on-screen displays, such as volume and MUTING may not be seen or may interfere with Closed Captions.
- Some cable systems and copy protection systems may interfere with the Closed Captioned signal.
- If using an indoor antenna or if TV reception is very poor, the Closed Caption Decoder may not appear or may appear with strange characters or misspelled words. In this case, adjust the antenna for better reception or use an outdoor antenna.

# ON/OFF TIMER

## ON TIMER SETTING

This feature allows you to have the TV automatically turn ON at predetermined time.

If you program the ON timer once the timer will turn ON the TV daily at the same time and to the same channel.  
If the power has been turned on at programmed time, the channel is changed to a programmed one.

1 Press the MENU button.

2 Press the CH + (▲) or CH - (▼) button until the indicator next to "ON/OFF TIMER" begins to flash, then press the ENTER button.

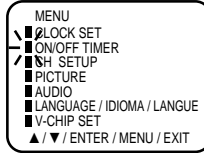

3 Press the CH + (▲) or CH - (▼) button until the indicator next to "ON TIMER" begins to flash, then press the ENTER button.

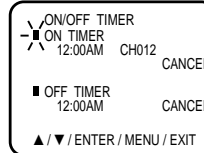

4 Press the CH + (▲) or CH - (▼) button to set the hour, then press the VOL + (▶) button.

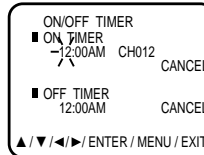

5 Press the CH + (▲) or CH - (▼) button to set the minute, then press the VOL + (▶) button.

- You can change in 10-minutes step by holding down the CH + (▲) or CH - (▼) button.

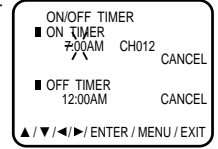

6 Press the CH+ (▲) or CH - (▼) button to set the channel, then press the VOL+ (▶) button.

- You can set the channel which is added in the "CH SET-UP" option.

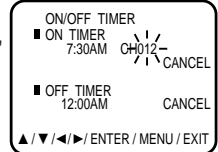

7 Press the CH + (▲) or CH - (▼) button to select the "SET" mode.

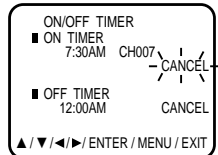

8 Press the EXIT button.

### NOTES:

- You cannot set the ON/OFF TIMER when the clock is not set.
- This TV will automatically turn off approximately 1 hour later after the ON TIMER turns on the TV unless any buttons are pressed.
- To cancel the ON TIMER function:  
To cancel ON TIMER in step 7 above press the CH + (▲) or CH - (▼) button to select the "CANCEL" mode.

## OFF TIMER SETTING

This feature allows you to have the TV turn "OFF" automatically at a predetermined time.

If you program the OFF TIMER once, The TV will be automatically turned off at the same time daily.

1 Press the MENU button.

2 Press the CH + (▲) or CH - (▼) button until the indicator next to "ON/OFF TIMER" begins to flash, then press the ENTER button.

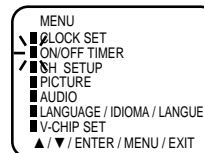

3 Press the CH + (▲) or CH - (▼) button until the indicator next to "OFF TIMER" begins to flash, then press the ENTER button.

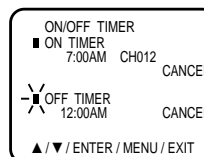

4 Press the CH + (▲) or CH - (▼) button to set the hour, then press the VOL + (▶) button.

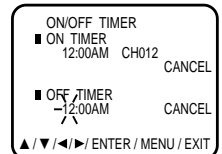

5 Press the CH + (▲) or CH - (▼) button to set the minute then press the VOL + (▶) button.

- You can change in 10-minutes step by holding down the CH + (▲) or CH - (▼) button.

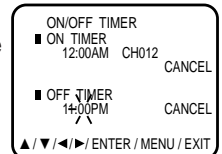

6 Press the CH + (▲) or CH - (▼) button to select the "SET" mode.

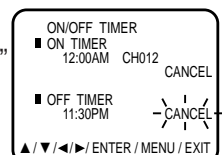

7 Press the EXIT button.

### NOTES:

- If station being viewed stops broadcasting, the TV will automatically shut itself off after 15 minutes.
- To cancel the OFF TIMER function:  
To cancel OFF TIMER, in step 7 above press the CH + (▲) or CH - (▼) button to select the "CANCEL" mode.

## SLEEP TIMER button

---

The Sleep Timer can turn the TV off for you after you fall asleep. Program it to work in intervals of 10 minutes, for a total time of up to 120 minutes.

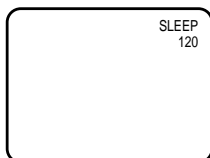

- To change the sleep timer setting:  
Press the SLEEP TIMER button repeatedly until the display turns to desired time.
- To cancel the sleep time:  
Press the SLEEP TIMER button repeatedly until the display turns to 0.

## VCR buttons

---

You can use this remote control to operate the basic functions of your VCR. These functions include: play, record, rewind, fast-forward, stop, pause, channel scan, TV /VCR, power on, and power off.

Move the selector switch to VCR to operate.

- The remote is preset with the code 000 to control JVC-brand VCR's. For any other manufacturer's brand VCR, please see the code chart and instructions on page 9.

## DVD buttons

---

You can also use this remote control to operate the basic functions of your DVD player. These functions include play, rewind, fast-forward, stop, still/pause, previous/next, tray open/close, power on, and power off.

Move the selector switch to DVD to operate.

- The remote is preset with the code 000 to control JVC-brand DVD players. For any other manufacturer's brand DVD player, please see the code chart and instructions on page 10.

## TV/CATV switch

---

Use either the television's own tuner or a cable box to select channels. Set this switch to TV to operate the television's built-in tuner.

Move the switch to CATV to operate a cable box.

- See page 8 for information on programming your remote for cable box operation.

## VCR/DVD switch

---

You can control a VCR or DVD player with the buttons on the lower part of the remote control.

Use the VCR/DVD selector switch to choose either VCR or DVD operation.

- See pages 9 and 10 for information on programming your remote with VCR and DVD operating codes.



# TROUBLESHOOTING GUIDE

Before requesting service, please refer to the following chart for the symptom and possible solution.

SYMPTOMS	POSSIBLE SOLUTIONS
TV does not operate	<ul style="list-style-type: none"> <li>• Make sure the power cord is plugged in.</li> <li>• Try another AC outlet.</li> <li>• Power is off, check fuse or circuit breaker.</li> <li>• Unplug unit for an hour, then plug it back in.</li> <li>• Set the 2 way selector switch on the remote control correctly (See page 6).</li> </ul>
Poor sound or No sound	<ul style="list-style-type: none"> <li>• Station or CATV experiencing problems, tune to another station.</li> <li>• Check sound adjustments (Volume and Muting).</li> <li>• Check for sources of possible interference.</li> </ul>
Poor picture or No picture	<ul style="list-style-type: none"> <li>• Station or CATV experiencing problems, tune to another station.</li> <li>• Make sure channels are set into memory.</li> <li>• Check antenna or CATV connections, reorient antenna.</li> <li>• Check for sources of possible interference.</li> <li>• Check picture control adjustments.</li> </ul>
Poor reception on some channels	<ul style="list-style-type: none"> <li>• Station or CATV experiencing problems, tune to another station.</li> <li>• Make sure channels are set into memory.</li> <li>• Station signal is weak, reorient antenna to receive desired station.</li> <li>• Check for sources of possible interference.</li> </ul>
Poor color or no color	<ul style="list-style-type: none"> <li>• Station or CATV experiencing problems, tune to another station.</li> <li>• Make sure channels are set into memory.</li> <li>• Check picture control adjustments.</li> <li>• Check antenna or CATV connections, reorient antenna.</li> <li>• Check for sources of possible interference.</li> </ul>
Picture wobbles or drifts	<ul style="list-style-type: none"> <li>• Station or CATV experiencing problems, tune to another station.</li> <li>• Make sure channels are set into memory.</li> <li>• CATV company is scrambling signal.</li> <li>• Check antenna orientation.</li> </ul>
No CATV reception	<ul style="list-style-type: none"> <li>• Check all CATV connections.</li> <li>• Set TV/CATV menu option to the CATV mode.</li> <li>• Station or CATV system problems, try another station.</li> </ul>
Horizontal or diagonal bars on screen	<ul style="list-style-type: none"> <li>• Check antenna connections, reorient antenna.</li> <li>• Check for sources of possible interference.</li> </ul>
No reception above channel 13	<ul style="list-style-type: none"> <li>• Make sure TV/CATV menu option is in the appropriate mode.</li> <li>• If using antenna, check UHF antenna connections.</li> </ul>
No Remote operation	<ul style="list-style-type: none"> <li>• Batteries are weak, dead or inserted incorrectly.</li> <li>• Remote is out of range, move closer to TV within (15 feet).</li> <li>• Make sure Remote is aimed at sensor.</li> <li>• Confirm there are no obstructions between the Remote and the TV.</li> <li>• Make sure the power cord is plugged in.</li> <li>• Set the 2 way selector switch on the remote control correctly (See page 6).</li> </ul>
TV shuts off	<ul style="list-style-type: none"> <li>• No broadcast on station tuned.</li> <li>• Sleep Timer is set.</li> <li>• ON/OFF TIMER is set.</li> <li>• Power interrupted.</li> <li>• Approximately 1 hour has passed after the ON TIMER turns on and no button was pressed (See page 21).</li> </ul>
Closed - Caption is not activated.	<ul style="list-style-type: none"> <li>• TV station experiencing problems or program tuned is not closed captioned. Try another channel.</li> <li>• Check CATV connection or VHF/UHF antenna, reposition or rotate antenna.</li> <li>• Press C.C. button to turn on the closed caption decoder.</li> </ul>
Display is not shown in your language.	<ul style="list-style-type: none"> <li>• Select proper language in the menu options.</li> </ul>
The remote control does not operate other product.	<ul style="list-style-type: none"> <li>• Set the 2 way selector switch on the remote control correctly (See page 6).</li> <li>• Program remote with a different code.</li> <li>• The remote control may not be compatible with your product.</li> <li>• Install new batteries.</li> </ul>
The remote control does not operate some features of other product.	<ul style="list-style-type: none"> <li>• Program remote with a different code.</li> <li>• The remote control may not be able to operate all features of your product.</li> </ul>

# SPECIFICATIONS

	AV-24F704	AV-20F704	AV-14F704
AC Power Input:	120 V, 60 Hz		
AC Power Consumption:	125W	105W	80W
Picture Tube:	24" (measured diagonally)	20" (measured diagonally)	14" (measured diagonally)
Audio Power Output Rating:	5 W + 5 W	2.5 W + 2.5 W	2.5 W + 2.5 W
Speaker:	2" x 4-3/4", 8 ohm x 2		1-5/8" x 2-13/16", 8 ohm x 2
Audio/Video Input:	COMPONENT Input: Y-Input: 1.0Vp-p, 75 ohm PB, PR-input: 0.7Vp-p, 75 ohm S-Video Input Y-Input: 1.0Vp-p, 75 ohm C-Input: 0.3Vp-p, 75 ohm Video Input: 1.0Vp-p, 75 ohm Audio Input: -8dB, 47k ohm		
Tuner Type:	181 Channel, Quartz PLL Frequency Synthesized		
Receiving Channels:	VHF UHF CATV		
Antenna Input Impedance:	75 ohm (VHF/UHF/CATV) Coaxial Input		
Dimensions:	26-1/2" (W) x 19-1/8" (D) x 20-1/8" (H)	23-1/4" (W) x 19-3/4" (D) x 17-1/2" (H)	17-1/8" (W) x 15-1/2" (D) x 13-5/8" (H)
Weight:	72.6 lbs	55.2 lbs	26.4 lbs

## ACCESSORIES:

Remote Control  
Batteries (2 x AA)

Specifications are subject to change without notice.

# JVC®

**JVC COMPANY OF AMERICA**  
Division of U.S. JVC CORP.  
1700 Valley Road  
Wayne, New Jersey 07470

**JVC CANADA, INC.**  
21 Finchdene Square  
Scarborough, Ontario  
Canada M1X 1A7